



H-BR 006

PAIR OF HORIZONTAL BRACKETS



Description Pair of brackets for 8" cabinets horizontal wall mounting.

Standard compliance Safety agency CE compliant

Size Weight 3.9 kg / 8.6 lbs

Physical specifications Color Black - RAL 9005, White - RAL 9003

Line Art 2D

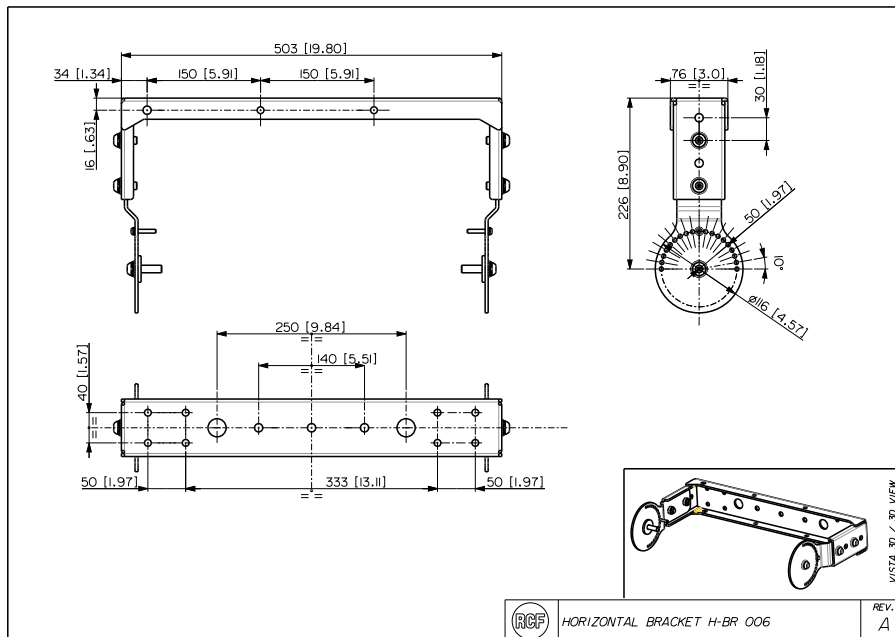

Part Number 13360547 H-BR 006
13360603 H-BR 006 W

Black - RAL 9005 EAN 8024530021627
White - RAL 9003 EAN 8024530021634

Technical Specifications

Products are continually improved. All specifications are therefore subject to change without notice.