



H-BR 004

PAIR OF HORIZONTAL BRACKETS



Description Pair of brackets for 5" cabinets horizontal wall mounting.

Standard compliance Safety agency CE compliant

Size Weight 1.6 kg / 3.53 lbs

Physical specifications Color Black - RAL 9005, White - RAL 9003

Line Art 2D

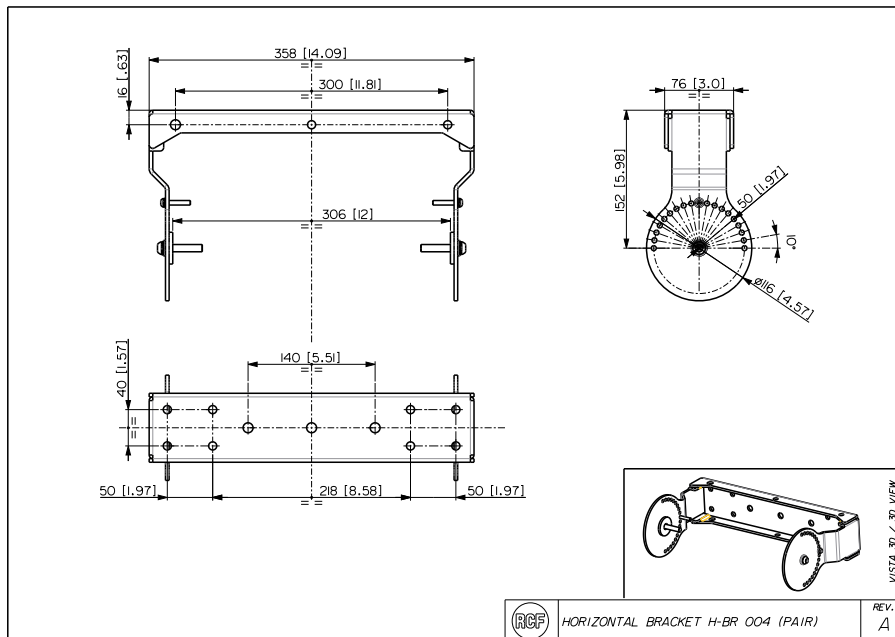

Part Number 13360550 H-BR 004
13360597 H-BR 004 W

Black - RAL 9005 EAN 8024530021580
White - RAL 9003 EAN 8024530021597

Technical Specifications

Products are continually improved. All specifications are therefore subject to change without notice.